



# Pit jack 20 000 kg PK20L



- Built in air pump
- Dual pump lifting system
- 2 lowering speeds
- Integrated air hydraulic pump
- Modular system



## Technical specifications

Capacity	20 000 kg
Required air pressure	7.5 t/m 12 Bar
Stroke	420 mm
Min. Height	576 mm
Max. Height	996 mm
Width	1100 tot 1400 mm
Depth	665 mm
Weight	295 kg

**NB! The pit jack is supplied without adapter plates! See back cover for more information.**

## Dimensions

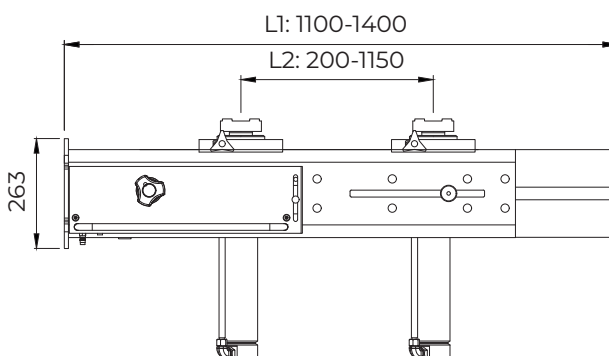
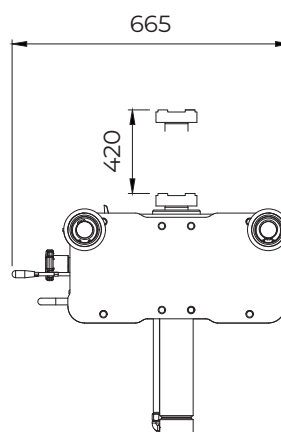

## Selecting the adapter plates

Use the dimensional drawing below to determine which adapter plates are most suitable.

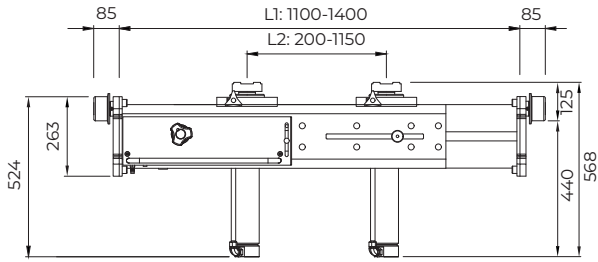

Pit jack dimensions with short adapter plates

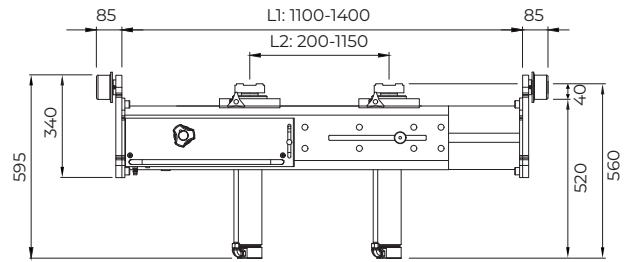

Pit jack dimensions with long adapter plates

## Rail

Determine the type of adapter plate wheels based on the rail.



Cylindrical rail



Conical rail

### PK01A Short plate cylindrical wheels

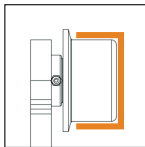

Cylindrical wheel

### PK02A Long plate cylindrical wheels

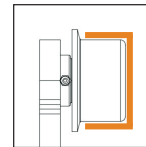

Cylindrical wheel

### PK03A Short plate conical wheels

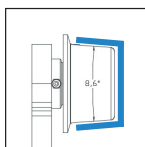

Conical wheel

### PK04A Long plate conical wheels

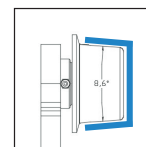

Conical wheel